

EP Internal Report 80-08
8 December 1980

DO YOU LIKE GEIGER COUNTERS?

E. Gygi and F. Schneider

GENEVA

1980

1. INTRODUCTION

A two-dimensional, cellular Geiger counter array is described. The number of hit cells is recorded on three read-out directions, and it is even possible to read out the signals of the individual cells directly with CMOS shift registers. Such a counter might be of interest as a sampling device in high-energy calorimetry. M. Conversi et al. have shown that a measurement of electromagnetic shower energy is possible by counting the number of flash-tubes of their hodoscope that are fired. A flash signal is independent of the number of particles traversing the tube, whereas in the proposed device a single tube, because of its subdivision, will be able to record many particles. The advantage will be either to have a finer sampling or to obtain the same information with a reduced number of wires. Gas discharge devices, working in the proportional mode and recording the ionization, are affected by the wide spread and the small size of the signals.

2. PRINCIPLES OF THE CELLULAR GEIGER COUNTER

The authors have already demonstrated, several years ago, that the propagation of a Geiger discharge can be stopped on a bead of insulating or conductive material which is surrounding the wire; a bead diameter of only twice the wire diameter suffices. A discharge produced between two beads gives rise to a pulse width with 3% r.m.s. Low energetic electrons which traverse a gaseous detector at a small angle (with respect to the wire) will spoil a calorimetric measurement. U. Amaldi and H.G. Fischer therefore proposed to stop the propagation of such electrons by introducing a sufficiently large number of spacers into the tube. These spacers can also serve to arrest a Geiger discharge between two of them.

The charge released in such a discharge can amount to the stored charge of the representing capacity, and can be more than 100 pC/cm of wire. The charge, obtained from a cell which contains only several millimetres of wire, can even be subdivided and recorded with a high signal-to-noise ratio on several read-out electrodes, or stored in CMOS circuits. In order to obtain the theoretical limit of charge, special care must be taken in the choice of the cathode material and the kind of quenching gas. An essential drawback of the Geiger mode compared to the proportional mode is its inherent dead-time: $t_d \sim bd^2$ (b: ion mobility; d: distance wire to cathode). If the usual carrier gas, namely Ar, is replaced by He, a factor of 3 is gained in mobility. Because the dead-time is restricted to an individual cell, background rates as high as 10^4 p/s cm^2 can be tolerated with the arrangement described.

3. DESIGN

Stainless-steel wires (W_i), 50 μm in diameter, are spaced 1 cm apart (see Fig. 1). Grounded metallic separation walls (W_a) of 1 mm thickness are interspaced; 2 mm thick spacers (S) of isolating material divide the tube into 10 mm long cells. A bottom plate (B) and a top plate (T) have, on their insides, read-out strips (R), eventually separated by grounded guard-strips (G). The outsides of the plates are metallized and grounded, so that the induced charges on the wire and the strips are well shielded.

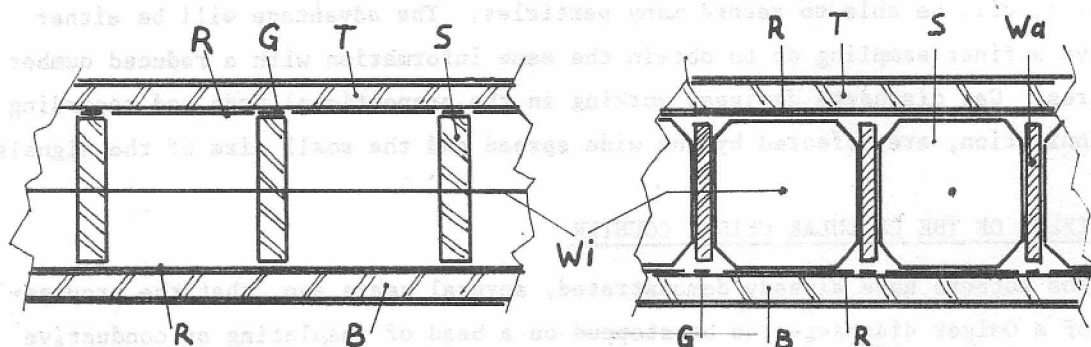

Fig. 1

4. PERFORMANCE AND OBSERVATIONS

All the following measurements have been performed with a chamber where the read-out strips have been arranged parallel and perpendicular with respect to the wire, and where adjacent strips have been separated by 1.5 mm wide guard-strips.

4.1 Discharge

In order to obtain reliable output pulses as high as possible and with a minimum of spurious breakdown, different cathode and spacer materials have been tested.

Gold, copper and stainless steel behave well, whereas aluminium and brass are not recommendable.

Good quenching gases are methyl and ethyl alcohol, and ethyl and amyl acetate, whereas molecular gases with small or no dielectric moment (higher mobility) are not usable.

From the breakdown point of view Ar and He are equally good as carrier gases, but He gives a 3 times larger mobility for the positive ions.

Finally, He + 1.5% ($^{\circ}\text{C}$) ethyl alcohol was used as a standard mixture. A recovery time of 80 μs has been measured, as can be seen from Fig. 2.

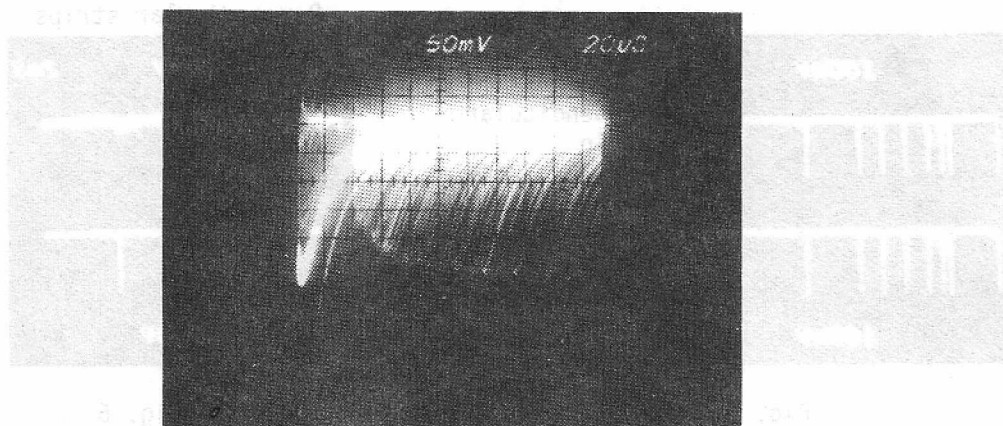

Fig. 2

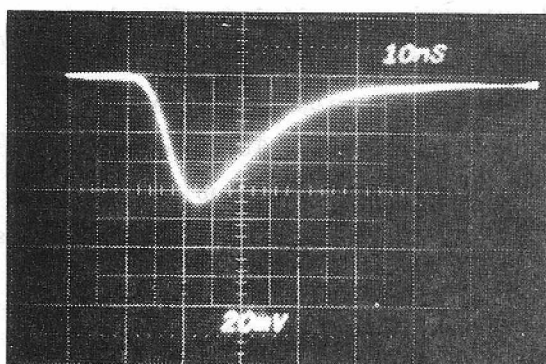

Fig. 3

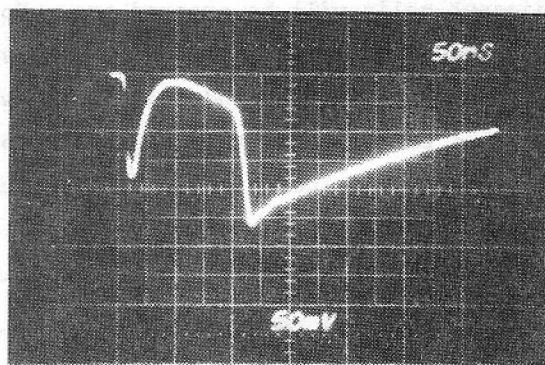

Fig. 4

A superposition of pulses taken from the anode wire on a 50Ω load is represented in Fig. 3.

At the limit of amplification the Geiger pulse is accompanied by an after pulse, as shown in Fig. 4. (For a $100 \mu\text{m}$ wire the breakdown threshold is smaller by a factor of 2.) These after pulses have been identified as caused by breakdowns over the surface of the spacers. So far two different spacer materials have been tested, namely PVC and Delrin; a safe operation for both, which yields 100 pC/cell , is easily possible. The spurious breakdown rate/cell is for Delrin $\approx 0.2/\text{s}$ and for PVC $\approx 0.1/\text{s}$, i.e. several times larger than the cosmic background rate.

Charge pulses, taken on the read-out strips parallel to the wire, contain 0.22 of the total charge and the corresponding figure for strips perpendicular

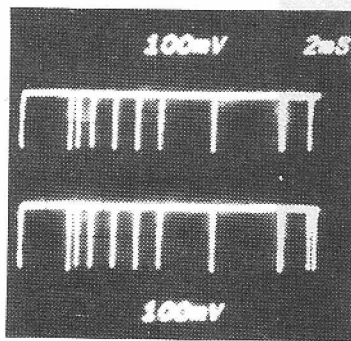

Fig. 5

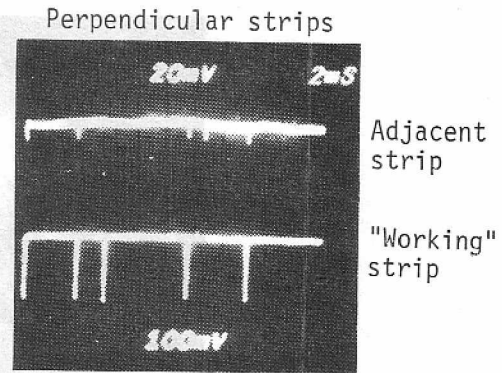

Fig. 6

to the wire is 0.19. See Fig. 5. The difference between the two figures is understandable. After the formation of the ion cloud, the electric field also shows a component parallel to the wire; hence, the induced current on the cathode is not only restricted to the area of the cell in question, but cathode areas of adjacent cells will be exposed too. For read-out strips parallel to the wire this effect is of no importance; however, for the case of perpendicular strips, adjacent ones will be induced. But, owing to the guard strips and the high ϵ (≈ 4) of the spacers, the cross-talk could be kept very small. The measured cross-talks (including a 4 m long Scotchflex multicore connecting cable and the internal coupling of amplifiers on the same chip) are $\approx 3\%$ for perpendicular strips and $< 1\%$ for the parallel ones. See Fig. 6.

The positive ions of the Geiger discharge which have been produced in the vicinity of the spacers will terminate their journey on the isolating material. According to the volumetric and surface conductivity of the spacers, the corresponding parasitic space charge (which perturbs the ideal, radial field configuration) will disappear more or less rapidly. From this consideration it is understandable that the pulse heights are dependent on the incident particle flux. Table 1 gives the measured figures for PVC spacers. (Delrin spacers are slightly worse.)

Table 1

Part./s and cell	420	100	12
Rel. pulse height on \parallel strip	0.96	0.98	1
Rel. pulse height on \perp strip	0.97	0.99	1

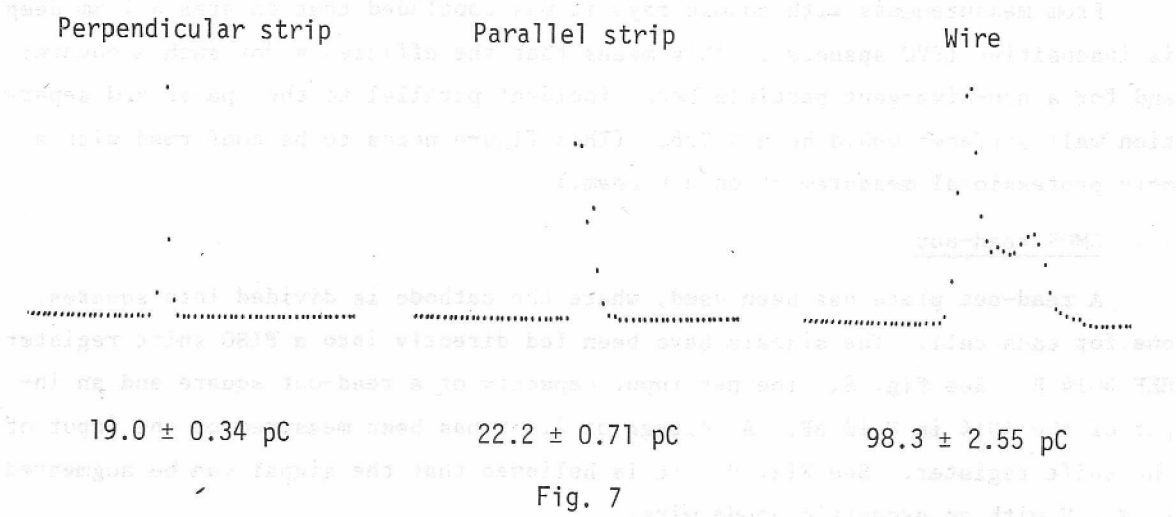

Figure 7 shows pulse-height spectra for the perpendicular strip, the parallel strip, and the wire.

4.2 Variations of amplification

In order to measure the sensitivity against mechanical imperfections, the distance of a read-out plate with respect to the wire has been altered by δ ; the following variation of the amplification A has been obtained:

$$\frac{\Delta A}{A} = 0.4 \delta \text{ (mm) .}$$

The variation with the alcohol concentration C as parameter has turned out to be:

$$\frac{\Delta A}{A} = -0.5 \frac{\Delta C}{C} , \text{ (C } \approx 1.5\%)$$

and that with the HV:

$$\frac{\Delta A}{A} = 3.3 \frac{\Delta V}{V} \text{ (V } \approx 1.35 \text{ kV) .}$$

4.3 Efficiency

As already mentioned, owing to the charging of the spacers (by positive ions), the electric field has a component perpendicular to the spacer surface. Electrons can be attracted by it. Besides that there exists a second phenomenon which gives rise to a field deformation, unfortunately in the same sense. The conductivity of insulators augments with increasing field. On the wire the field is ≈ 100 kV/cm, whereas on the cathode it is ≈ 200 times smaller. An appreciable lowering of the field will result where the wire is touching a spacer. If all primary electrons are produced within a certain distance from the spacer surface, no Geiger discharge will occur because the electrons cannot reach the wire. One has to expect a dead area, dependent upon the spacer material and the incident particle flux.

From measurements with cosmic rays it was concluded that an area $\lesssim 1$ mm deep is insensitive (PVC spacers). This means that the efficiency for such a counter and for a non-divergent particle beam, incident parallel to the spacer and separation wall surfaces would be $\eta \approx 0.6$. (This figure needs to be confirmed with a more professional measurement on a μ beam.)

4.4 CMOS read-out

A read-out plate has been used, where the cathode is divided into squares, one for each cell. The signals have been fed directly into a PISO shift register HEF 4014 B. See Fig. 8. The net input capacity of a read-out square and an input of the 4014 is ≈ 10 pF. A voltage of 2.5 V has been measured on the input of the shift register. See Fig. 9. It is believed that the signal can be augmented to ≈ 4 V with an excentric anode wire.

The manufacturers of CMOS circuits give as typical figures for the lower limit of transition 0.45 and for the corresponding higher limit 0.55 of the supply voltage, i.e. a typical noise level of ± 1 V can be tolerated for a 5 V supply. With that voltage the maximum shift frequency is 5 MHz. If 5 ms are available for read-out, it is possible to obtain from *one* read-out wire the information of 10^4 cells or of 1 m² of detector area.

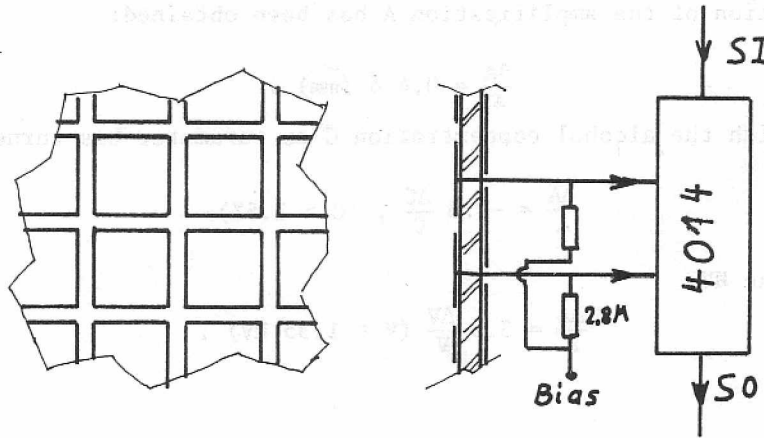

Fig. 8

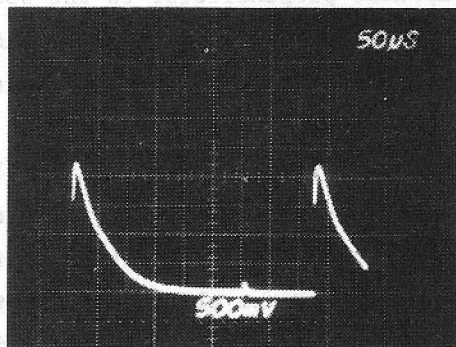

Fig. 9

5. CONCLUSIONS

Owing to its high amplification, such a detector has an outstanding signal-to-noise ratio. It is easily possible to identify up to 10 hits/read-out electrode. With the information of three read-out electrodes [read-out strips $\pm 45^\circ$ inclined with respect to the wire (tested)] and the number of discharged cells, a high degree of unambiguous reconstruction of multiparticle events is possible. It will certainly not be easy to construct a larger device with the required mechanical tolerances.

In the read-out version with CMOS shift registers, the mechanical tolerances are much more relaxed, the information is *unambiguous* and the number of connecting cables (with the outside world) can be reduced very much; but the number of elements that a large detector presents is enormous (15 years ago the MWPC conception was also enormous!).

It seems that neither version is very cheap. Whether or not the MGC (Multi Geiger Counter) conception will be the best one for the construction of a shower calorimeter would be the subject of a further study.

Acknowledgements

The authors would like to thank Mr. M. Jimenez for the precise mechanical construction and Dr. U. Amaldi for his stimulating interest.

From this figure you get a feeling about what a "Geiger counter" looks like

APPENDIX

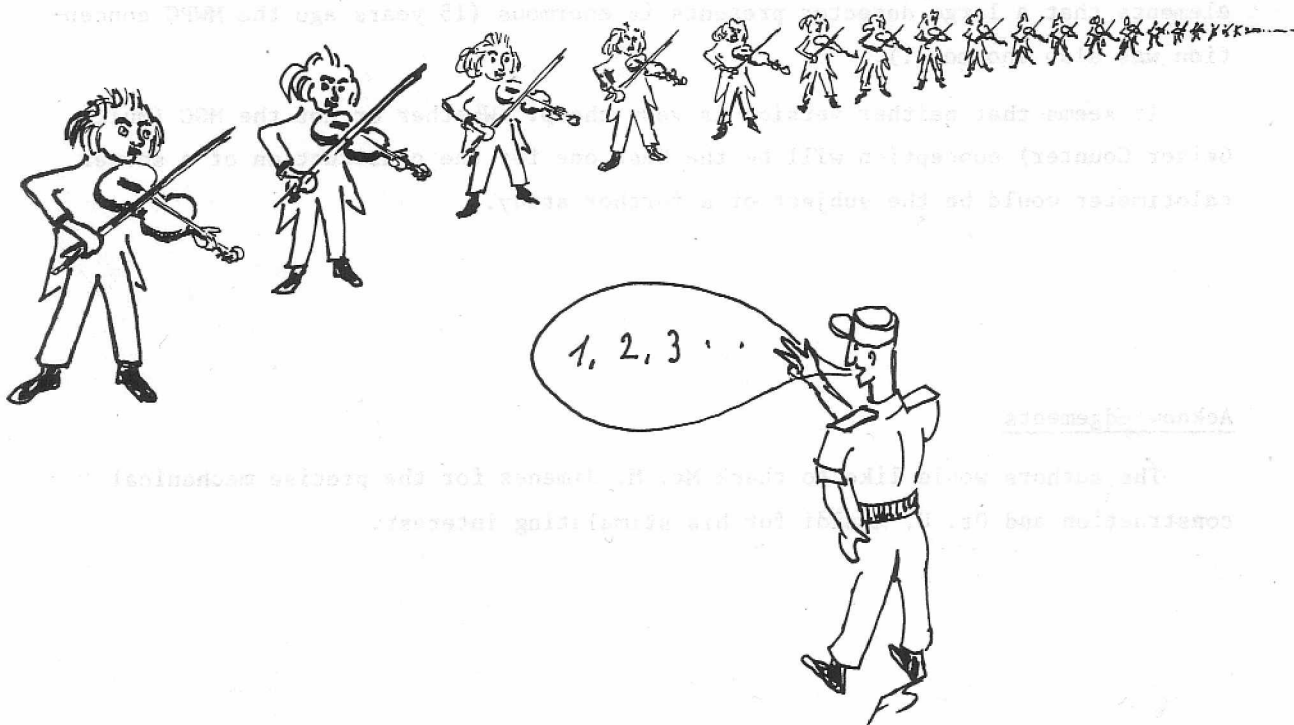

From this figure you get a feeling about what a "Geiger counter" looks like